

Cerniera in Acciaio Inox AISI 316 con Foro Passante AISI 316 Stainless Steel Hinge with Through Hole

INOX
Stainless Steel

Cod.	A	D	I	C	d1	B	H	U.V.
A3CCX40	40	40	25	25	5,5	5	9	20
A3CCX50	50	50	30	30	6,5	6	11,5	20
A3CCX60	60	60	36	36	8,5	8	14,5	20

Caratteristiche

Materiale: Acciaio Inox AISI 316

Product specification

Material: AISI 316 stainless steel

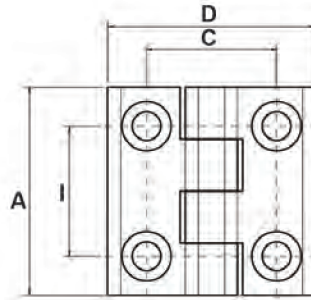
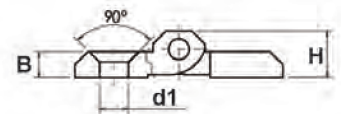
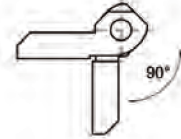

Q - QX

Pistoncino di Posizionamento con Filetto Passo Fine Index Bolt without Stop, Fine-Pitch Thread, Steel or Stainless Steel

INOX
Stainless Steel

Cod.	D	d1	d2	I1	I2	I3	I4	SW	Forza inizio molla Spring force start N	Forza fine molla Spring force end N	Filetto Thread	U.V.
B1Q2105	21	5	M10x1,0	45,0	6	17	5	12	6	15	Brunito	20
B1Q2506	25	6	M12x1,5	54,5	6	20	6	14	8	21	Brunito	20
B1Q3108	31	8	M16x1,5	69,0	8	26	8	19	9	26	Brunito	20
B1Q3110	31	10	M20x1,5	80,0	10	33	10	22	17	40	Brunito	20
B1QX2105	21	5	M10x1,0	45,0	6	17	5	12	6	15	Inox	20
B1QX2506	25	6	M12x1,5	54,5	6	20	6	14	8	21	Inox	20
B1QX3108	31	8	M16x1,5	69,0	8	26	8	19	9	26	Inox	20
B1QX3110	31	10	M20x1,5	80,0	10	33	10	22	17	40	Inox	20

Caratteristiche

Materiale corpo: Manopola in poliammide nero

Parte Metallica e/o Fissaggio:

Perno forato con testa esagonale in acciaio brunito o acciaio Inox

Note:

Disponibile con controdado fornito separatamente, su specifica richiesta, vedi articolo DQ - DQX

Product specification

Main Part Material: Knob in black polyamide
Metal and/or Fastening part:

Indexing Bolt with hexagonal head in stainless steel or steel gunmetal finish

Note:

Screws thread also available with thread lock supplied separately on request, see article DQ-DQX

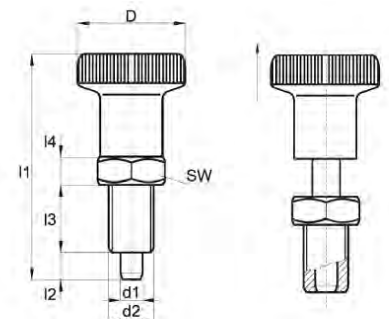

QS - QSX

Pistoncino di Posizionamento a Molla con Arresto in Posizione Retratta, Filetto Passo Fine

Index Bolt with Stop, Fine-Pitch Thread, Steel or Stainless Steel

INOX
Stainless Steel

Cod.	D	d1	d2	l1	l2	l3	l4	SW	Forza inizio molla Spring force start N	Forza fine molla Spring force end N	Filetto Thread	U.V.
B1QS2105	21	5	M10x1,0	51	5	17	5	12	6	15	Brunito	20
B1QS2506	25	6	M12x1,5	61	6	20	6	14	8	21	Brunito	20
B1QS3108	31	8	M16x1,5	75,5	8	26	8	19	9	26	Brunito	20
B1QS3110	31	10	M20x1,5	91	10	33	10	22	17	40	Brunito	20
B1QSX2105	21	5	M10x1,0	51	5	17	5	12	6	15	Inox	20
B1QSX2506	25	6	M12x1,5	61	6	20	6	14	8	21	Inox	20
B1QSX3108	31	8	M16x1,5	75,5	8	26	8	19	9	26	Inox	20
B1QSX3110	31	10	M20x1,5	91	10	33	10	22	17	40	Inox	20

Caratteristiche

Materiale corpo:

Manopola in poliammide nero

Parte Metallica e/o Fissaggio:

Perno forato con testa esagonale in acciaio brunito o acciaio Inox

Note:

Disponibile con controdado fornito separatamente, su specifica richiesta, vedi articolo DQ - DQX

Product Specification

Main part material:

Knob in black polyamide

Metal and/or Fastening part:

Indexing Bolt with hexagonal head in stainless steel or steel gunmetal finish

Note:

Screws thread also available with thread lock supplied separately on request, see article DQ-DQX

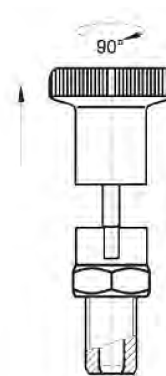
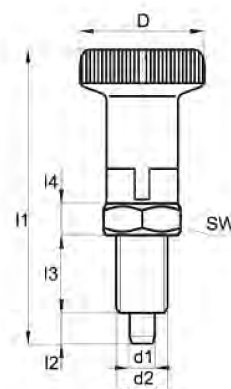

DQ - DQX

Dadi DIN 439 passo fine per pistoncini a molla

Lock Nuts DIN 439 for Index Bolts

INOX
Stainless Steel

Cod.	d1	Colore Colour	U.V.
B1DQ10	M10x1,0	Zincato nero passo fine Black zinc plated	20
B1DQ12	M12x1,5	Zincato nero passo fine Black zinc plated	20
B1DQ16	M16x1,5	Zincato nero passo fine Black zinc plated	20
B1DQ20	M20x1,5	Zincato nero passo fine Black zinc plated	20
B1DQX10	M10x1,0	Inox passo fine Stainless steel	20
B1DQX12	M12x1,5	Inox passo fine Stainless steel	20
B1DQX16	M16x1,5	Inox passo fine Stainless steel	20
B1DQX20	M20x1,5	Inox passo fine Stainless steel	20

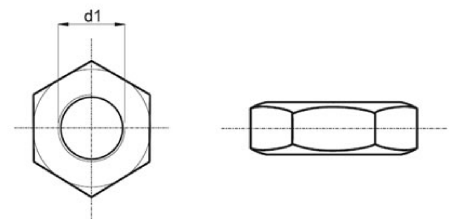

Caratteristiche

Controdadi DIN 439 per pistoncini a molla, in acciaio zincato nero o acciaio Inox. Vedi articoli Q-QX-QS-QSX

Product specification

Lock Nuts DIN 439 for Index Bolts, black zinc plated or Stainless Steel. See articles Q-QX-QS-QSX

PI

Pistoncino di Arresto a Molla

Spring Locking Bolt, Threaded

Cod.	D	d1	d	h1	h	H	h3	h2	Chiave Spanner	Peso Weight gr	U.V.
B1PI200510	20	M10x1	5	11	5	32	11	5	14	23	20
B1PI200612	20	M12x1,5	6	11	6	33	11	5	14	20	20
B1PI200712	20	M12	7	11	7	34	11	5	14	21	20
B1PI200812	20	M12x1,5	8	11	6	33	11	5	14	22	20
B1PI300612	30	M12x1,5	6	11	6	44	22	5	14	25	20
B1PI300616	30	M16x1,5	6	11	6	49	22	9	19	30	20
B1PI300712	30	M12	7	11	7	45	22	5	14	26	20
B1PI300716	30	M16x1,5	7	11	7	49	22	9	19	31	20
B1PI300812	30	M12x1,5	8	11	7	45	22	5	14	28	20
B1PI300816	30	M16x1,5	8	11	7	49	22	9	19	32	20

Caratteristiche

Materiale Corpo:

Tecnopolimero rinforzato con fibre di vetro di colore nero, resistente a solventi, oli, grassi (PA)

Parte Metallica e/o Fissaggio:

Punte e dado in acciaio carbonitrurato zincato

Product specification

Main Part Material:

Black fiberglass-reinforced technopolymer, resistant to solvents, oils, greases (PA)

Metal and/or Fastening part:

Stud and nut in carbonitruded zinc plated steel

