

# MA5

series

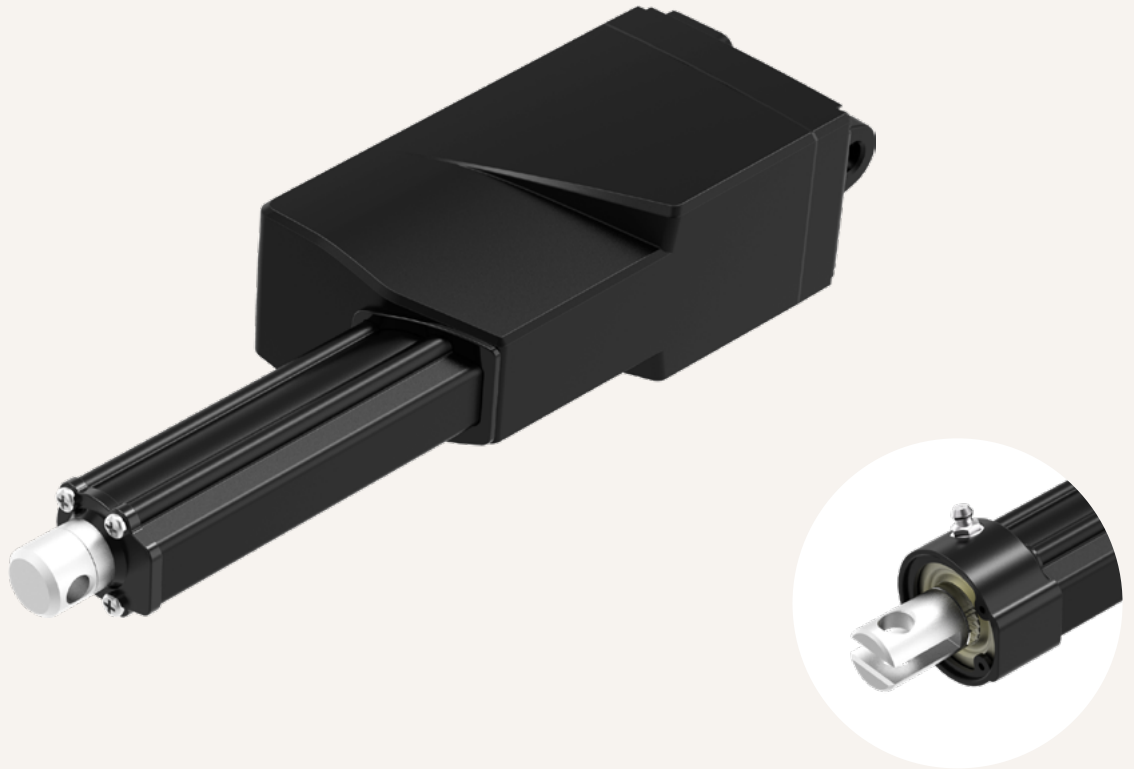

## Product Segments

- **Industrial Motion**

TiMOTION's MA5 electric linear actuator is specifically designed for applications that face harsh working environments and require ruggedness and durability. Its IP69K protection can withstand high-pressure water jets, and the ingress of dust and other solid contaminants. The MA5 can also be customized with various feedback options depending on the application requirements; moreover, it can be equipped with a grease nipple to increase the protection degree and life cycle. Suitable applications for MA5 include agricultural equipment, such as valves, spreaders, harvesters, and grain handlers.

### General Features

Max. load	3,500N (push); 2,000N (pull)
Max. speed at max. load	2.4mm/s
Max. speed at no load	56.5mm/s
Retracted length	≥ 200mm (depending on chosen options)
IP rating	IP69K
Stroke	20~1000mm
Output signals	Mechanical pot., NPN Hall sensor
Options	Grease chamber
Voltage	12/24/48V DC; 12/24/48V DC (PTC)
Operational temperature range	-25°C~+65°C
Operational temperature range at full performance	+5°C~+45°C

**Drawing**

Standard Dimensions  
(mm)

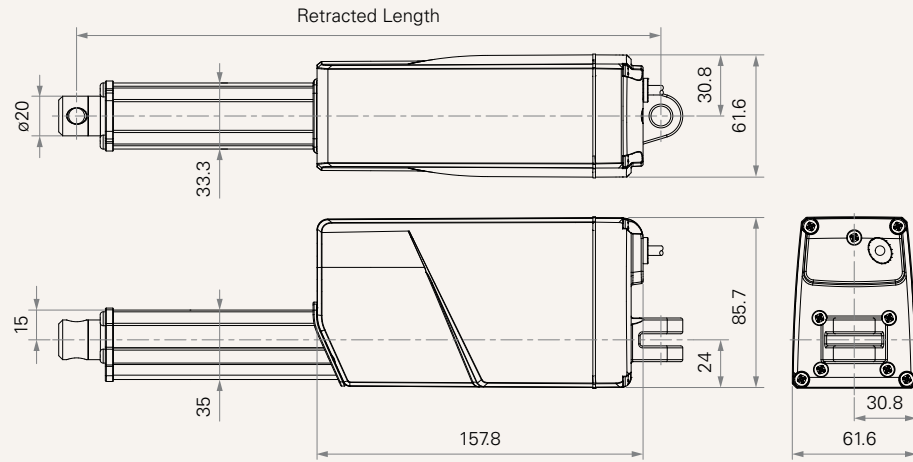

With Grease Chamber  
Standard Dimensions  
(mm)

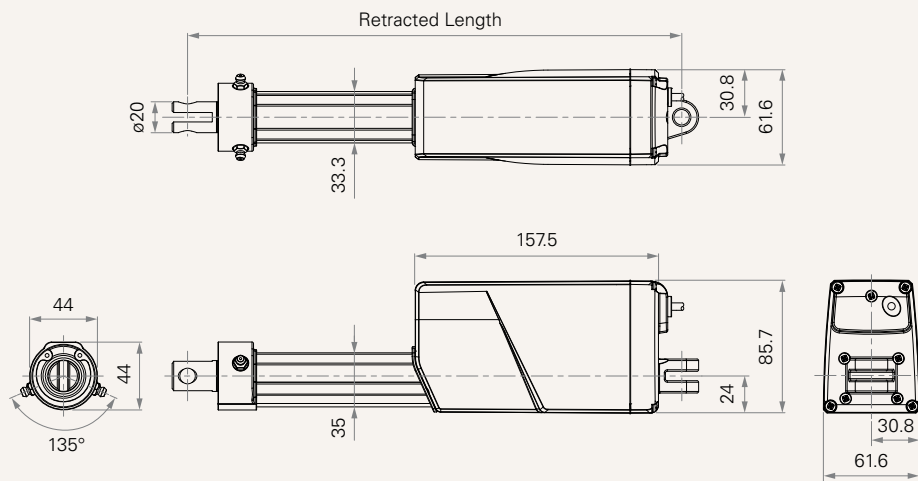

### Load and Speed

CODE	Load (N)		Self Locking Force (N)	Typical Current (A)		Typical Speed (mm/s)	
	Push	Pull		No Load 24V DC	With Load 24V DC	No Load 24V DC	With Load 24V DC
<b>Motor Speed (5200RPM, duty cycle 25%)</b>							
<b>A</b>	250	250	250	1.2	2.3	43.0	36.0
<b>B</b>	500	500	500	1.1	2.3	25.8	23.0
<b>C</b>	1000	1000	1000	1.1	2.3	14.0	11.8
<b>D</b>	1500	1500	1500	1.0	2.2	9.0	8.0
<b>E</b>	2000	2000	2000	1.0	2.2	7.1	6.2
<b>W</b>	500	500	500	1.3	5.0	54.0	35.0
<b>Motor Speed (6600RPM, duty cycle 25%)</b>							
<b>F</b>	250	250	250	1.6	2.8	56.5	45.0
<b>G</b>	500	500	500	1.5	2.8	32.5	28.5
<b>H</b>	1000	1000	1000	1.5	2.8	16.5	14.3
<b>K</b>	1500	1500	1500	1.3	2.8	11.1	10.0
<b>L</b>	2000	2000	2000	1.3	2.8	8.8	7.7
<b>Motor Speed (3800RPM, duty cycle 25%)</b>							
<b>S</b>	3500	2000	3500	0.9	2.8	3.2	2.4
<b>Motor Speed (2200RPM, duty cycle 25%)</b>							
<b>T</b>	2000	2000	2000	0.3	1.2	3.2	2.4

### Note

- 1 Please refer to the approved drawing for the final authentic value.
- 2 This self locking force level is reached only when a short circuit is applied on the terminals of the motor. All the TiMOTION control boxes have this feature built-in.
- 3 The current & speed in table are tested with 24V DC motor. With a 12V DC motor, the current is approximately twice the current measured in 24V DC; speed will be similar for both voltages.
- 4 The current & speed in table are tested when the actuator is extending under push load.
- 5 The current & speed in table and diagram are tested with TiMOTION control boxes, and there will be around 10% tolerance depending on different models of the control box. (Under no load condition, the voltage is around 32V DC. At rated load, the voltage output will be around 24V DC)
- 6 Without load, noise level  $\leq 78$ dB(A) (by TiMOTION test standard, ambient noise level  $\leq 36$ dB(A))
- 7 Standard stroke: Min.  $\geq 20$ mm, Max. please refer to below table.

CODE	Load (N)	Max Stroke (mm)
<b>A, F</b>	$\leq 250$	1000
<b>B, G, W</b>	$\leq 750$	800
<b>C, H</b>	$\leq 1000$	600
<b>D, K</b>	$\leq 1500$	500
<b>E, L, T</b>	$\leq 2000$	450
<b>S</b>	$\leq 3500$	300

**Performance Data (24V DC Motor)**

Motor Speed (5200RPM)

Speed vs. Load

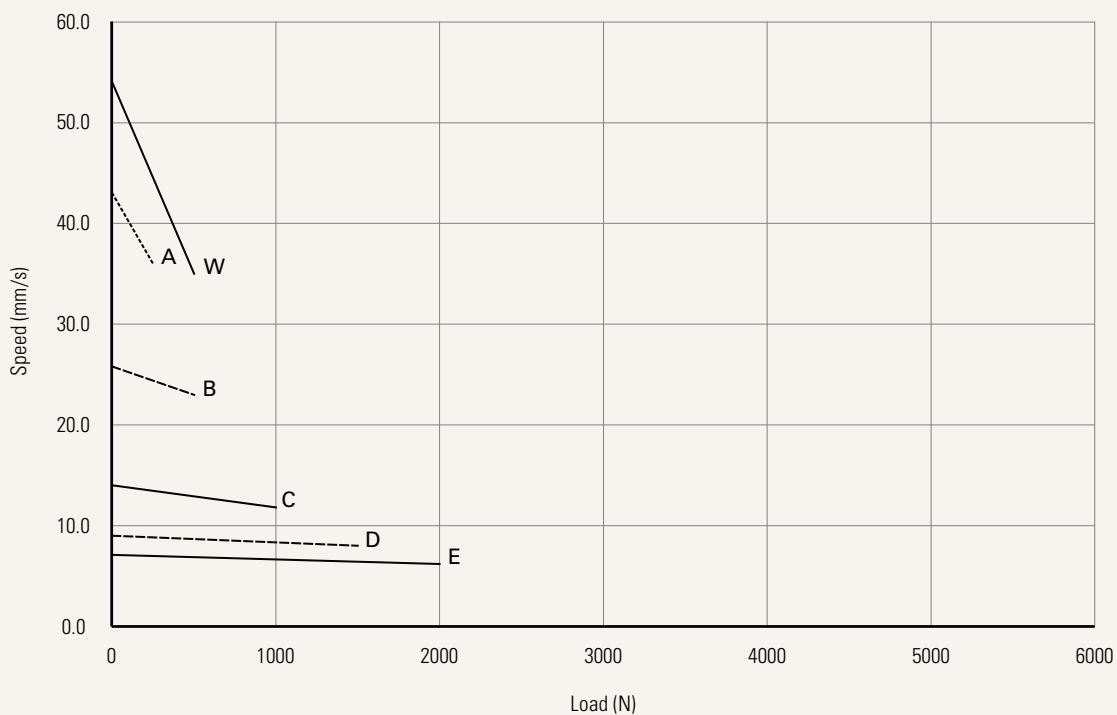

Current vs. Load

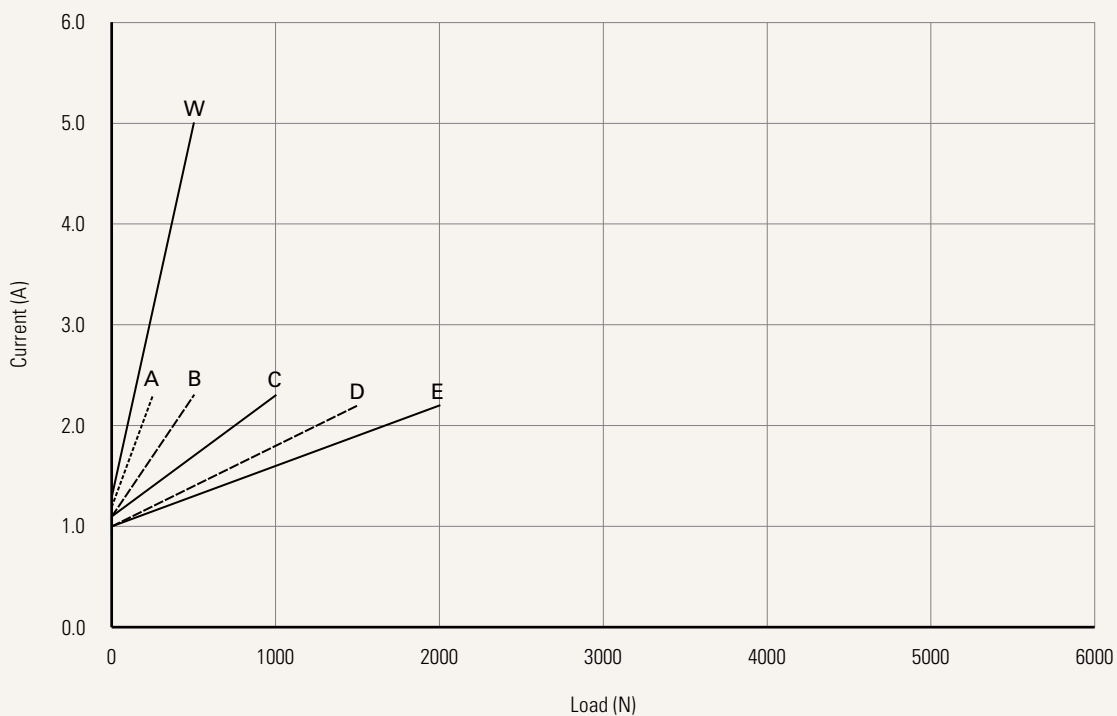

**Performance Data (24V DC Motor)**

Motor Speed (6600RPM)

Speed vs. Load

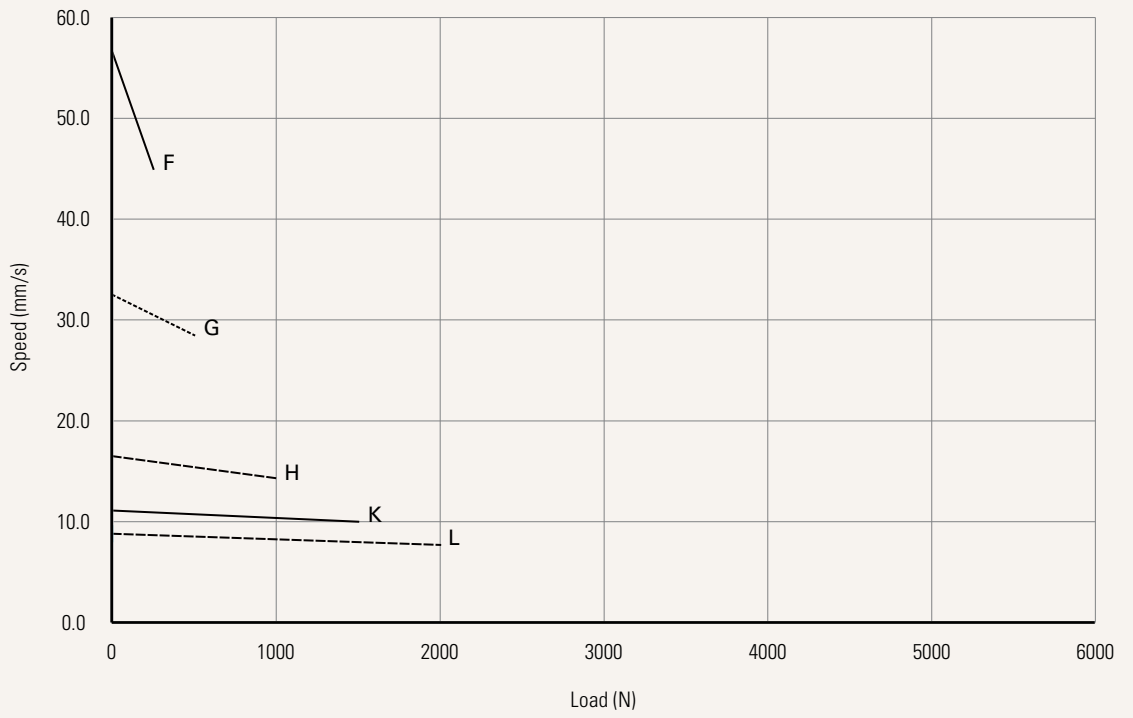

Current vs. Load

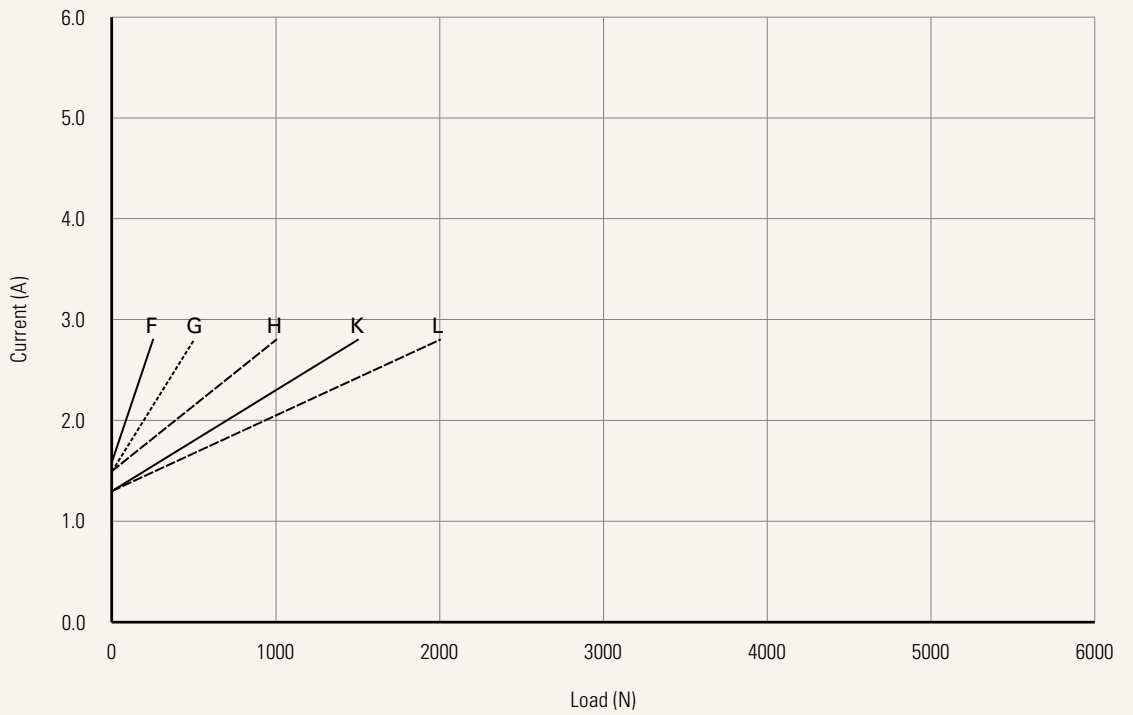

**Performance Data (24V DC Motor)**

Motor Speed (3800RPM)

Speed vs. Load

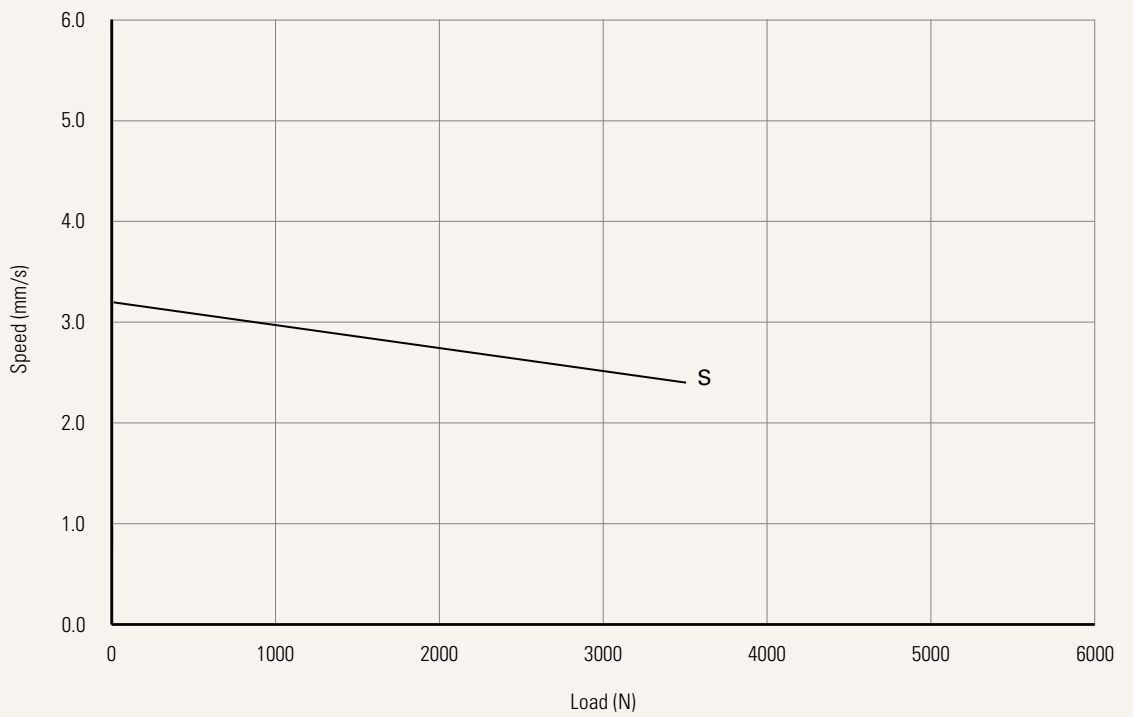

Current vs. Load

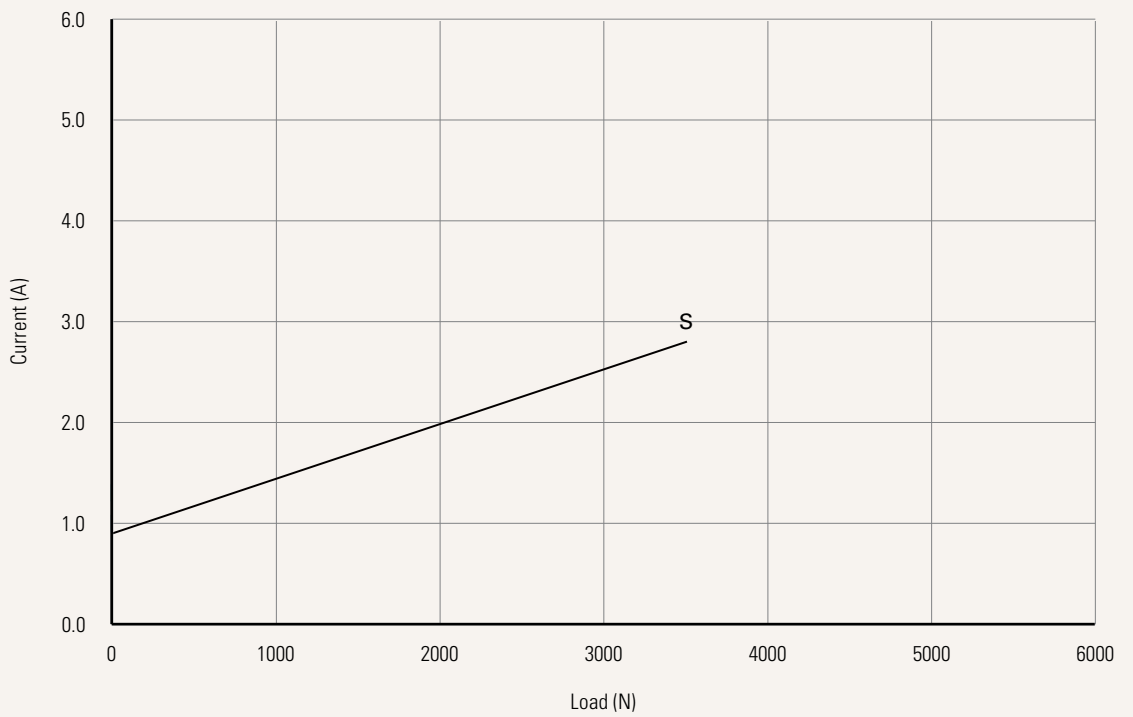

**Performance Data (24V DC Motor)**

Motor Speed (2200RPM)

Speed vs. Load

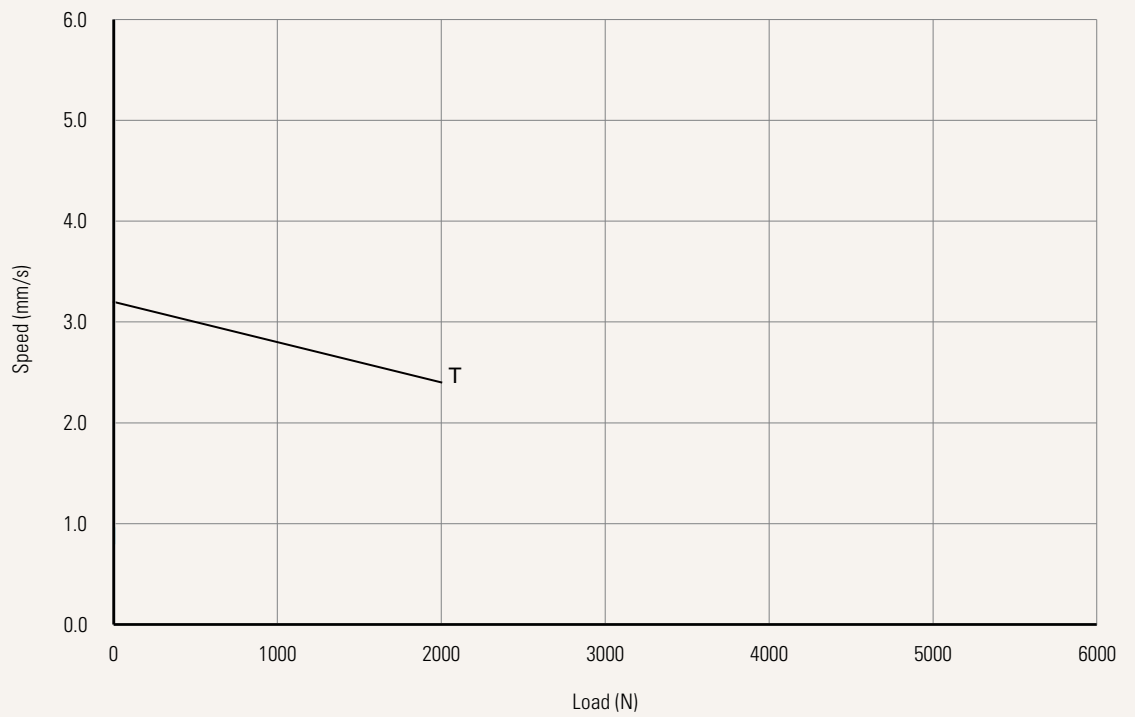

Current vs. Load

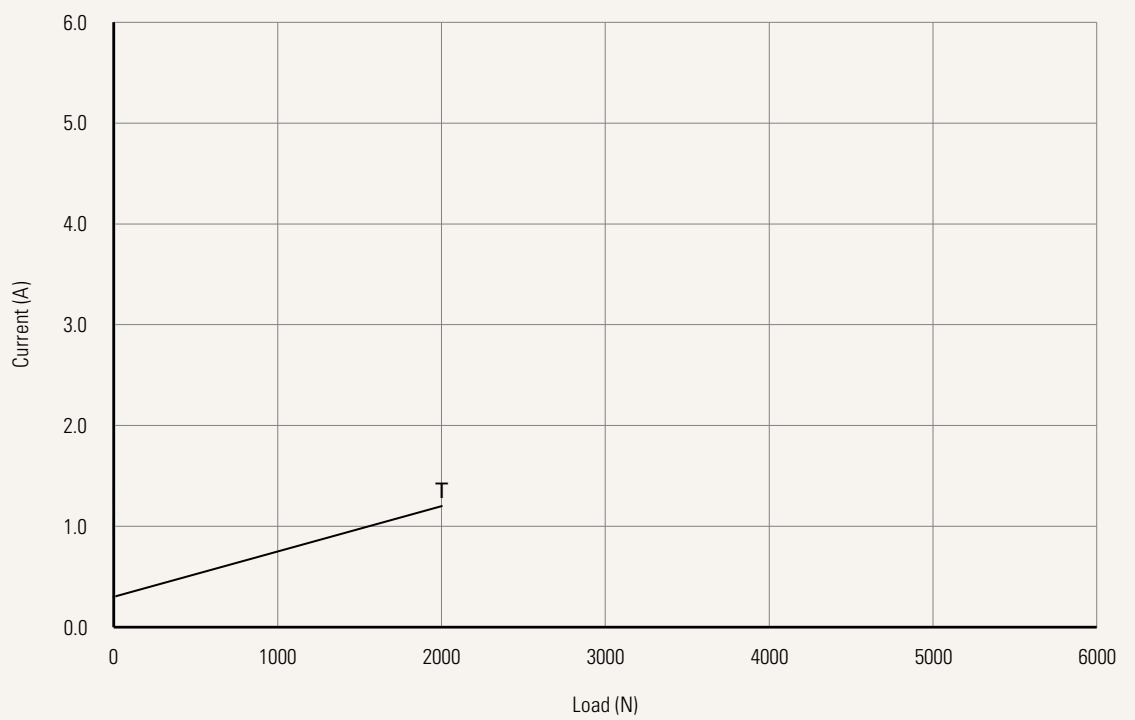

<b>Voltage</b>	1 = 12V DC 2 = 24V DC	4 = 48V DC 6 = 12V DC, PTC	5 = 24V DC, PTC 8 = 48V DC, PTC
<b>Load and Speed</b>	<a href="#">See page 3</a>		
<b>Stroke (mm)</b>	<a href="#">See page 3</a>		
<b>Retracted Length (mm)</b>	<a href="#">See page 9</a>		
<b>Rear Attachment (mm)</b> <a href="#">See page 10</a>	4 = Aluminum, U clevis, slot 6.0, width 10.5, hole 6.4, one piece casting with gearbox 5 = Aluminum, U clevis, slot 6.0, width 10.5, hole 8.0, one piece casting with gearbox	6 = Aluminum, U clevis, slot 6.0, width 10.5, hole 10.1, one piece casting with gearbox	
<b>Front Attachment (mm)</b> <a href="#">See page 10</a>	1 = Aluminum, slotless, hole 6.4 2 = Aluminum, slotless, hole 8.0 3 = Aluminum, U clevis, slot 6.0, depth 16.0, hole 10.0	4 = Aluminum, U clevis, slot 6.0, depth 16.0, hole 6.4 5 = Aluminum, U clevis, slot 6.0, depth 16.0, hole 8.0	
<b>Direction of Rear Attachment (Counterclockwise)</b> <a href="#">See page 10</a>	1 = 90°	2 = 0°	
<b>Functions for Limit Switches</b> <a href="#">See page 11</a>	1 = Two switches cut off the actuator at end of stroke (EOS) 2 = Two switches cut off the actuator at EOS + in-between third one sends signal 3 = Two switches send signal at EOS 4 = Two switches send signal at EOS + third one in between sends signal		
<b>Output Signals</b>	0 = Without	1 = Mechanical pot.	N = NPN Hall sensor*2
<b>Connector</b> <a href="#">See page 11</a>	1 = DIN 6P, 90° plug	2 = Tinned leads	
<b>Cable Length (mm)</b>	1 = Straight, 300	2 = Straight, 600	3 = Straight, 1000
<b>IP Rating</b>	6 = IP66M	9 = IP69K	
<b>Wiper Set &amp; Grease Nipple</b>	0 = Normal wiper, without grease chamber 1 = Enhanced wiper set, with grease chamber, grease nipple * 1 2 = Enhanced wiper set, with grease chamber, grease nipple * 2 3 = Enhanced wiper set, with grease chamber, without grease nipple		



## Retracted Length (mm)

1. Calculate  $A+B+C = Y$
2. Retracted length needs to  $\geq$  Stroke + Y
3. The total Retracted length calculated must be equal or longer than below minimum value
  - (1) When choosing the wiper set #0: And the front attachment is #1, #2, min retracted length  $\geq$  200mm, And the front attachment is #3, #4, #5, min retracted length  $\geq$  212mm
  - (2) When choosing the wiper set #1, #2, #3: And the front attachment is #1, #2 min retracted length  $\geq$  238mm, And the front attachment is #3, #4, #5 min retracted length  $\geq$  250mm

### A. Front Attachment

<b>1, 2</b>	+112
<b>3, 4, 5</b>	+124

### B. Load V.S. Stroke

Stroke (mm)	Load (N)	
	< 3500	= 3500
<b>20 ~150</b>	-	+5
<b>151~200</b>	+2	+7
<b>201~250</b>	+2	+7
<b>251~300</b>	+2	+7
<b>301~350</b>	+12	+17
<b>351~400</b>	+22	+27
<b>401~450</b>	+32	+37
<b>451~500</b>	+42	+47
<b>501~550</b>	+52	+57
<b>551~600</b>	+62	+67
<b>601~650</b>	+72	+77
<b>651~700</b>	+82	+87
<b>701~750</b>	+92	+97
<b>751~800</b>	+102	+107
<b>801~850</b>	+112	+117
<b>851~900</b>	+122	+127
<b>901~950</b>	+132	+137
<b>951~1000</b>	+142	+147

### C. Output Signals

<b>0, N</b>	-
<b>1</b>	+30

### D. Wiper Set & Grease Nipple

<b>0</b>	-
<b>1, 2, 3</b>	+10

## Rear Attachment (mm)

4 = Aluminum, U clevis, slot 6.0, width 10.5, hole 6.4, one piece casting with gearbox

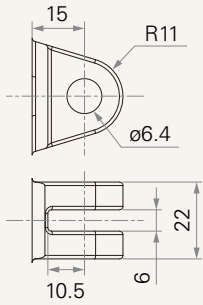

5 = Aluminum, U clevis, slot 6.0, width 10.5, hole 8.0, one piece casting with gearbox

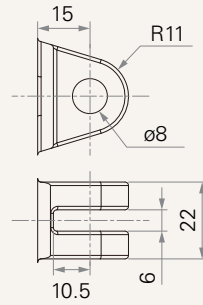

6 = Aluminum, U clevis, slot 6.0, width 10.5, hole 10.1, one piece casting with gearbox

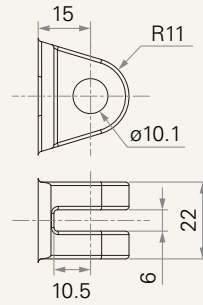

## Front Attachment (mm)

1 = Aluminum, slotless, hole 6.4

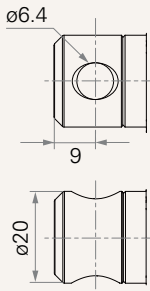

2 = Aluminum, slotless, hole 8.0

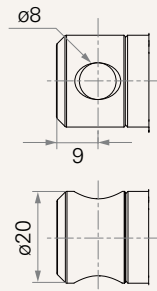

3 = Aluminum, U clevis, slot 6.0, depth 16.0, hole 10.0

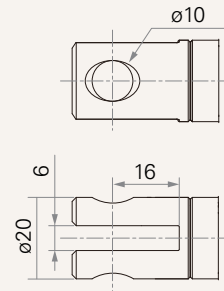

4 = Aluminum, U clevis, slot 6.0, depth 16.0, hole 6.4

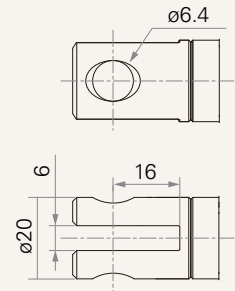

5 = Aluminum, U clevis, slot 6.0, depth 16.0, hole 8.0

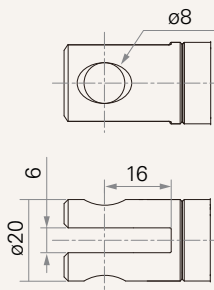

## Direction of Rear Attachment (Counterclockwise)

1 = 90°

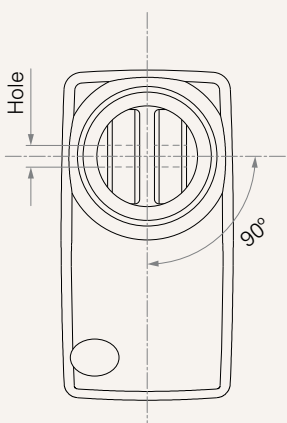

2 = 0°

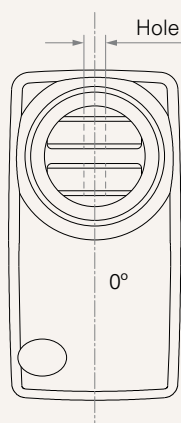

## Functions for Limit Switches

### Wire Definitions

CODE	Pin					
	● 1 (Green)	● 2 (Red)	○ 3 (White)	● 4 (Black)	● 5 (Yellow)	● 6 (Blue)
1	extend (VDC+)	N/A	N/A	N/A	retract (VDC+)	N/A
2	extend (VDC+)	N/A	middle switch pin B	middle switch pin A	retract (VDC+)	N/A
3	extend (VDC+)	common	upper limit switch	N/A	retract (VDC+)	lower limit switch
4	extend (VDC+)	common	upper limit switch	medium limit switch	retract (VDC+)	lower limit switch

### Connector

1 = DIN 6P, 90° plug

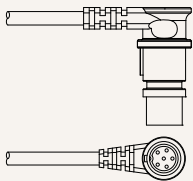

2 = Tinned leads

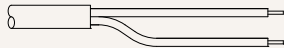

### Terms of Use

The user is responsible for determining the suitability of TiMOTION products for a specific application. TiMOTION products are subject to change without prior notice.